

Standard Slider Bedding Conveyor

Model Number: STD 10-20

Serial Number: _____

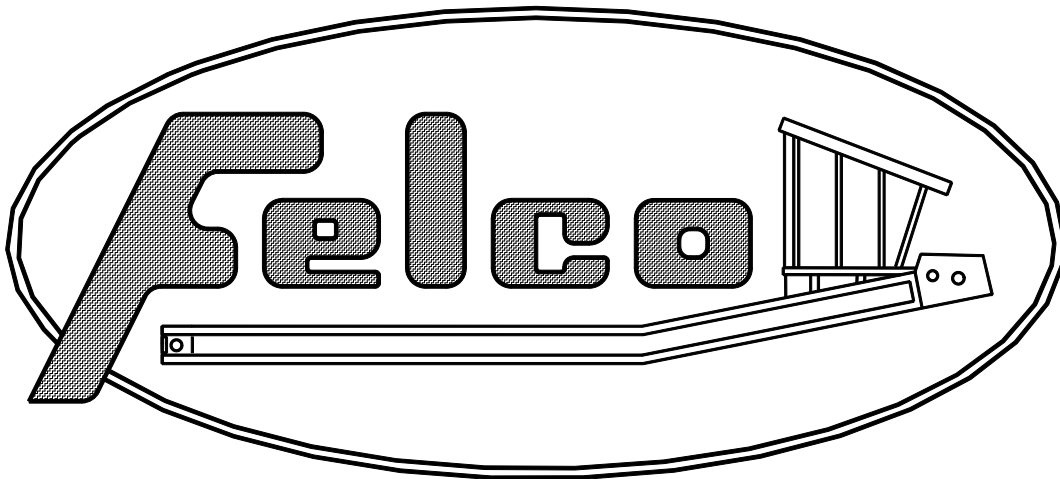

Bedding Conveyor Patent Number: 4,462,747

Felco Industries, Ltd.

3660 Grant Creek Road

P O Box 16750

Missoula, Montana 59808-6750

(406) 728-9103 1-800-221-5427

Fax (406) 543-4221

Table of Contents

Section 1	Introduction & Scope
.....	Page 4
Section 2	Overview
.....	Page 5
Section 3	Technical Specifications
.....	Pages 6 - 7
Section 4	Carrier Application
.....	Page 8
Section 5	General Operation
.....	Page 9
Section 6	Mounting & Removal
.....	Page 10
Section 7	Troubleshooting
.....	Page 11
Section 8	Parts
.....	Pages 14 - 39
Section 9	Hydraulic Schematics
.....	Pages 43 - 45

Section 1

Introduction & Scope

This manual contains important information for the safe use and maintenance of the Felco Bedding Conveyor. Read this manual thoroughly before installing, operating or repairing the Bedding Conveyor. This manual must be accessible to operators, service and transport personnel. Store this manual in a convenient location.

Pay careful attention to all instructions and follow all governing regulations. Operation or service other than in accordance with these instructions may subject the Bedding Conveyor to conditions beyond its design capability. Improper operation, service or the use of non-Felco parts may result in Bedding Conveyor failure or personal injury.



Instructions identified with this symbol are important for personal safety and full service life of the Bedding Conveyor.

Section 2

Overview

The Felco Bedding Conveyor is mounted to the undercarriage of crawler excavators. It is used for the purpose of delivering bedding material into the excavator's bucket or directly into the ditch. Normally you will want to fill the bucket with material for more precise placement in the ditch, but for large quantities of material needed around such things as manholes the material can be delivered directly into the ditch.

The Bedding Conveyor is made up of four main assemblies. The main frame, the nose section, the Power unit assembly and the hopper. Refer to Section 8 of this manual for a parts breakdown list.

The Bedding Conveyor is driven by a hydraulic motor. The source of hydraulic supply to the motor is from the track

drive system of the excavator. The conveyor is positioned so that the discharge end is at the drive sprockets of the excavator. Depending on the make of excavator, actual operation of the conveyor will vary, but all forms of operation will include using one of the travel pedals to supply hydraulic flow to the Bedding Conveyor motor.

After the initial installation of the Bedding Conveyor, mounting or removal of the conveyor is a quick and simple procedure. The hydraulic supply lines to the Bedding Conveyor motor have quick couplers for fast connection. The Bedding Conveyor is pinned to the excavator and the excavator can be used for lifting and removal of the conveyor. Refer to Section 6 for specific instructions on mounting and removal.

Section 3

Technical Specifications

Operation

<u>Belt Speed</u>	<u>750 Feet per minute</u>
<u>Hydraulic Flow</u>	<u>40 gpm</u>
<u>Operating Pressure - Load</u>	<u>2400-3000 psi</u>
<u>Operating Pressure - No Load</u>	<u>2000-2600 psi</u>
<u>Hydraulic Capacity</u>	<u>0.5 gal Approximate</u>

Standard Configuration

<u>Weight</u>	<u>7,500 lbs</u>
<u>Height</u>	<u>8'6"</u>
<u>Width</u>	<u>10'6"</u>
<u>Length</u>	<u>25'6"</u>
<u>Reduction of Excavator ground clearance</u>	<u>12"</u>
<u>Hopper Capacity</u>	<u>6 cy</u>

Belt Configuration

<u>Belt Width</u>	<u>24"</u>
<u>Belt Length</u>	<u>50'10"</u>
<u>Belt Specs</u>	<u>3 ply 330 - 1/8 x Fabric Back</u>
<u>Belt Lace</u>	<u>Flexco J375 x 24</u>

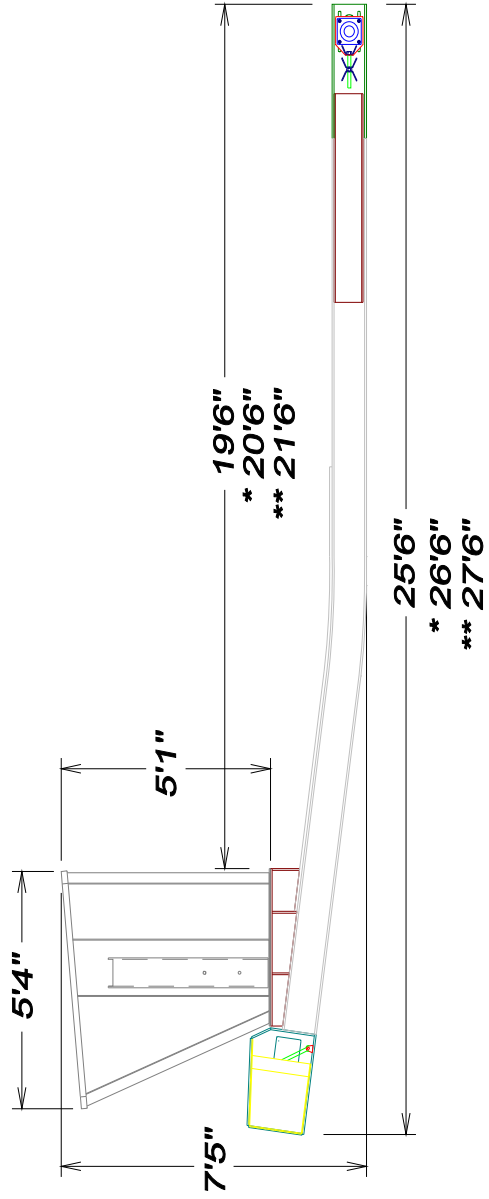
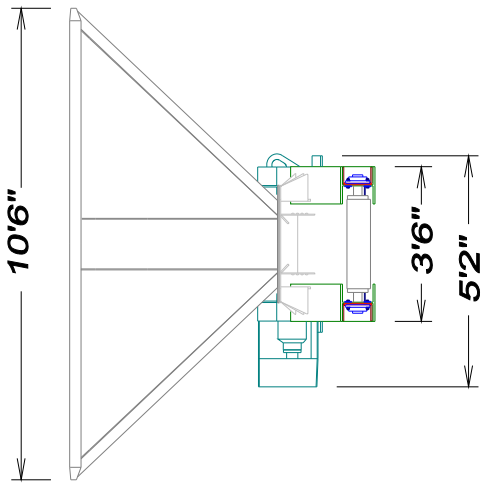

* WITH 1' EXTENSION INSTALLED

** WITH 2' EXTENSION INSTALLED

STANDARD SLIDER CONVEYOR

3693

Section 4

Carrier Application

The Felco Standard Bedding Conveyor is designed for use on medium to large crawler type excavators. Typically, carriers weigh 60,000 to 150,000 lbs. The carrier must have adequate ground clearance and hydraulic capacities to properly and safely operate the Bedding Conveyor.

A Felco installation kit is recommended to properly install the Bedding Conveyor. Felco installation kits are designed for each carrier. Each kit contains the proper mechanical, electrical and hydraulic components for optimum performance.

Always follow hydraulic kit installation instructions. Carrier hydraulic circuits differ and damage to the Bedding Conveyor or carrier may result if the hydraulic kit is improperly installed. Contact Felco for installation recommendations.

Section 5

General Operation & Maintenance

The Bedding Conveyor is designed to operate under a wide range of conditions and is low maintenance. Conditions to avoid are extremely muddy or rocky conditions.

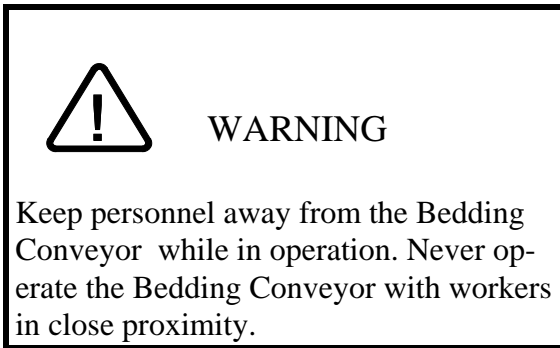

The Bedding Conveyor is powered by the excavator's track drive system. To run the conveyor, activate the electrical switch in the cab and, while keeping the switch activated, depress the track pedal. The correct track pedal and the direction it is depressed will be determined at the time of installation.

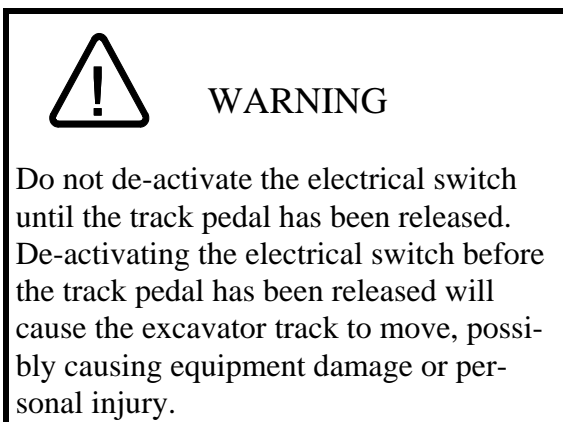

1. Daily before operating, Carefully inspect:
 - a. Hoses and fittings for leaks and other damage.
 - b. Mounting hardware and pins for damage.
 - c. Electrical components for proper operation.
2. Repair or replace any damaged components prior to operation.
3. At beginning of each day, run the conveyor empty and:
 - a. Check belt alignment, adjust as necessary with the adjusting bolts at the drive pulley end or the nose pulley end or both.
 - b. Check belt tension, adjust as necessary.
 - c. Check the metering gate at the discharge of the hopper. The gate should be adjusted as high as possible without the material over flowing the skirt boards or running into the car body of the excavator.
4. Lubricate bearings at the same interval as the excavator is lubricated. There are 6 bearings: 2 at the nose pulley end and 4 at the drive pulley end.
5. At the end of the day, empty the hopper of any material. Material left in the hopper overnight can become packed and hard to remove the next day.
6. Monthly, check the oil level in the drive gearbox. Add SAE 50 weight oil as necessary.

Section 6

Mounting & Removal

After the initial installation is complete, mounting and removal of the Bedding Conveyor is relatively simple. The procedure listed should be followed to ensure minimal equipment damage and personal safety.

	WARNING
Use proper lifting methods and rigging equipment in well-maintained condition to avoid equipment damage and personal injury.	

To mount the Bedding Conveyor:

1. Place conveyor on ground, using a block positioned under the hopper end of the conveyor to keep the nose end of the conveyor flat on the ground. Make sure there is room around the conveyor to walk the excavator over the top of it.
2. Walk the excavator over the top of the conveyor. Make sure the orientation of the excavator is correct with the conveyor. Visually, try to line up the mounting eyes on the conveyor with the mounting eyes on the excavator.
3. Reach the excavator's bucket over the top of the hopper and use a choker or

chain of adequate capacity in the lifting eyes on the power unit. With the choker secured in the bucket's hook, lift the conveyor until the rear mounting eyes of the conveyor line up with the rear mounting eyes of the excavator. The operator may need to swing the bucket to one side or the other or walk the excavator forward or backwards to align the pin holes.

4. Insert the pins in the mounting eyes.

Note: If the Bedding Conveyor is pinned to a Mounting beam, line up the 2 mounting eyes nearest the excavator and insert those pins. Then lower the excavator's bucket slightly until the outside 2 pin holes line up and insert those pins.

5. Lower the excavator bucket until the discharge end of the conveyor rises up and engages the front mounting eyes.
6. Insert the pins in the mounting eyes.
7. Remove the rigging from the conveyor and excavator bucket.

	WARNING
Keep fingers clear of mounting eyes. Do not put any part of body under suspended loads.	

Section 7

Troubleshooting

1. Bedding Conveyor does not run:

- a. Insufficient oil pressure or flow. Check hydraulic supply system. Correct as required.
- b. Material packed in hopper. Inspect and clean if required.
- c. Material packed in conveyor frame. Inspect and clean if required.
- d. Belt tension too loose. Inspect and adjust as required. With the belt empty of material; inspect belt tension at the curved portion of the main frame. In this area the belt will bow upwards. Press down on the belt until it contacts the slider bed, estimate the distance traveled. A 2" bow in the belt will be the minimum required to turn the belt. Increase the tension. as required.

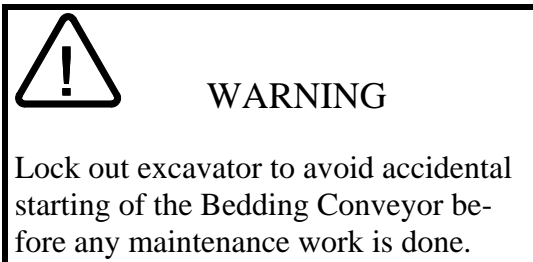

- e. Skirt board rubber tight against belt. There should be 1/8" to 1/4" clearance between the skirt board rubber and the belt. Adjust as required.
- f. Quick couplers not connected. Make sure all quick couplers are fully connected.

2. When trying to run the Bedding Conveyor, the track runs instead of the conveyor.

- a. Check that operating procedures are being followed. Must activate the switch and keep activated for the duration of running the conveyor.
- b. Inspect electrical system. Electrical contacts must be kept clean and in good operating condition. Clean contacts and check connections and correct as required.
- c. Test electric solenoid coil for continuity. Replace as required.

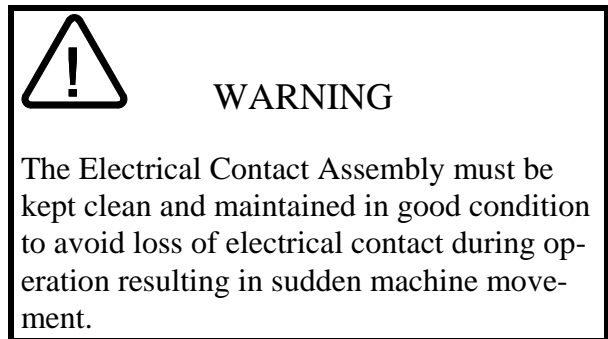

With the conveyor running, no material comes out of the hopper.

- a. If the bedding material is wet, bridging in the hopper can occur, with sand being the worst for this problem. If wet material is being used, it may become necessary to add a hydraulic vibrator to the side of the hopper. A complete kit, which runs in parallel with the conveyor, can be purchased from Felco.

Section 8

Conveyor and Hydraulic Parts

Conveyor Parts Page 14 - 21

Hydraulic Parts..... Pages 22 - 39

Parts listed are all parts for all excavators. Your machine may not have some of the parts shown. Contact Felco's Technical Service Department for assistance.

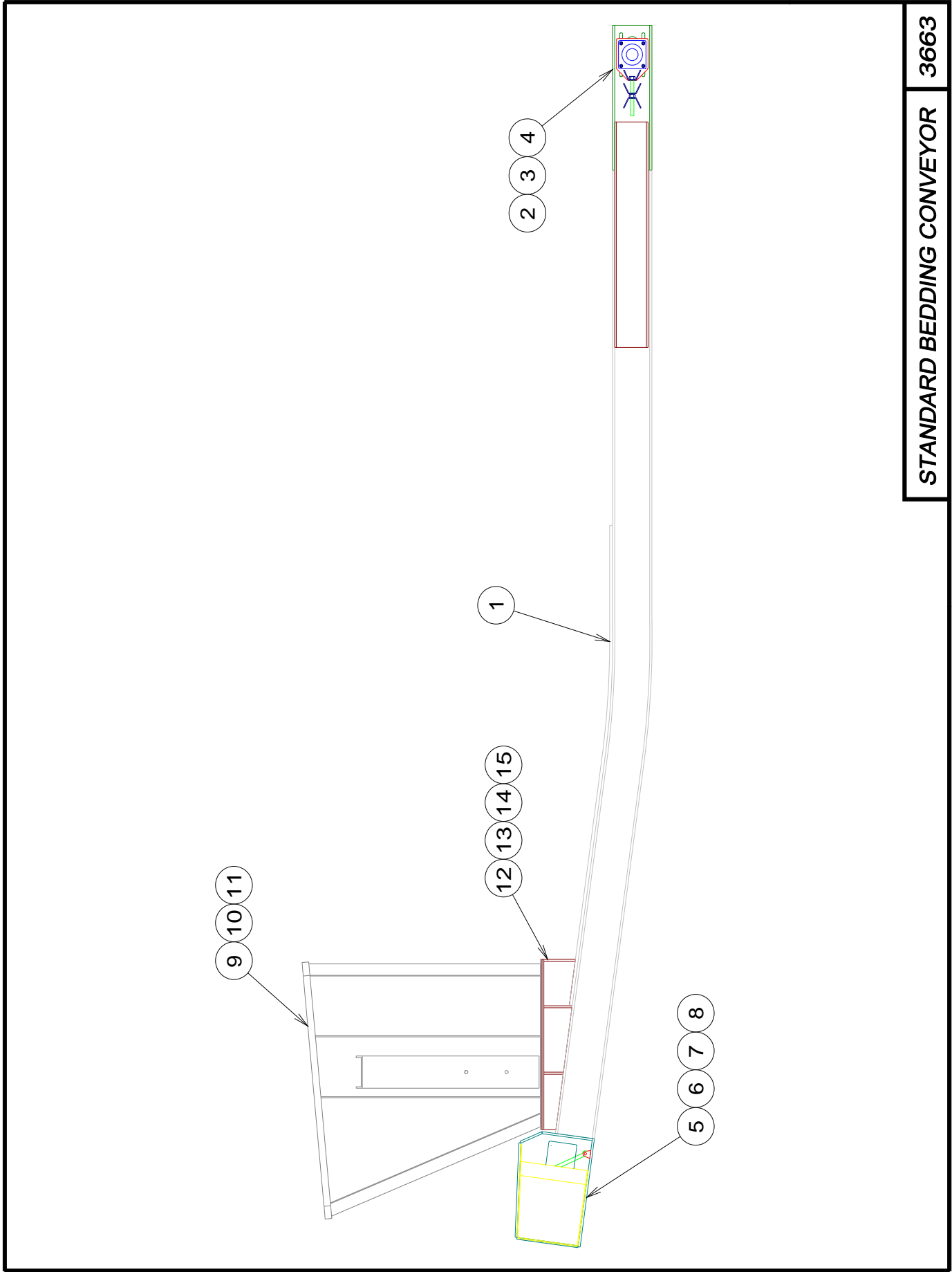

3663

STANDARD BEDDING CONVEYOR

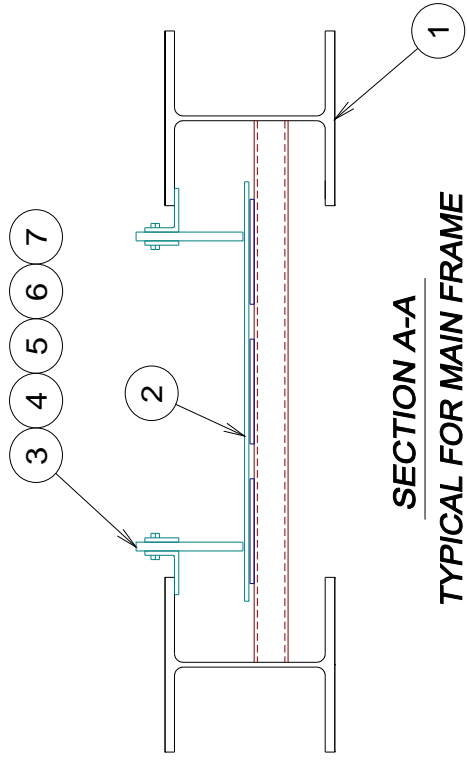

SECTION A-A
TYPICAL FOR MAIN FRAME

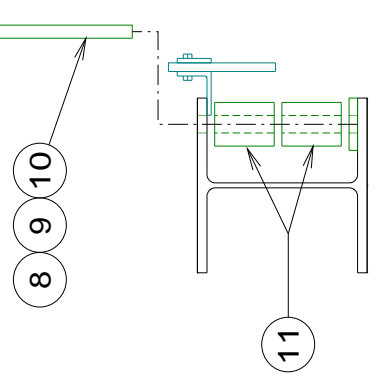

SECTION B-B

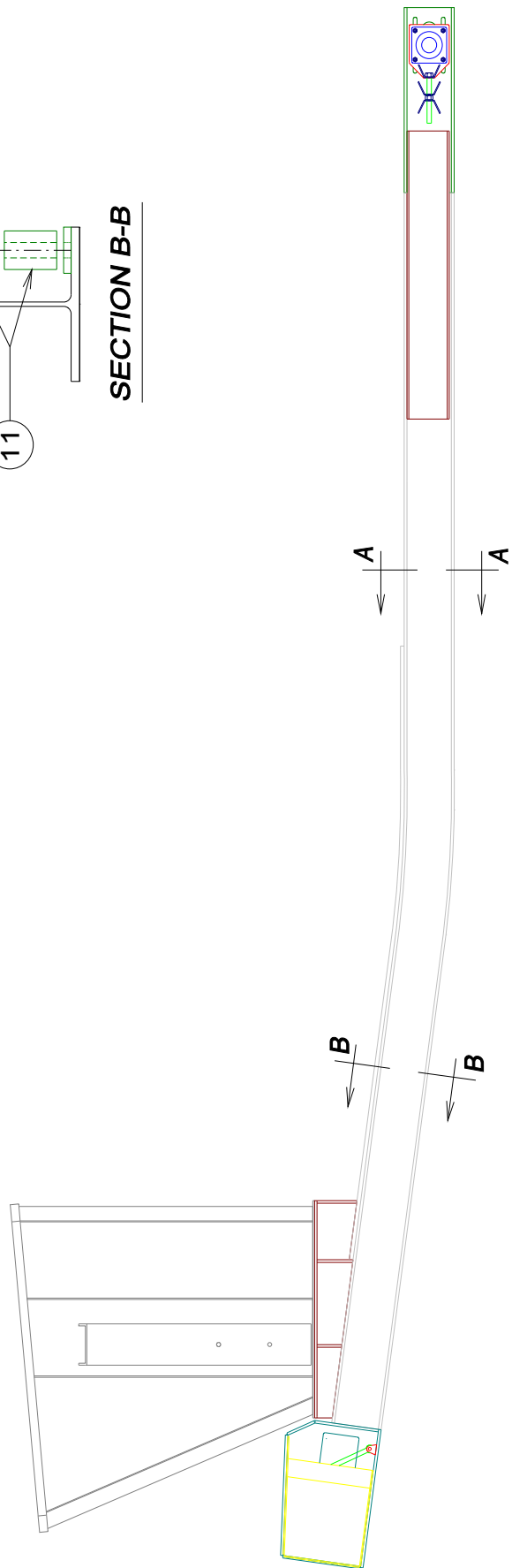

STANDARD MAIN FRAME ASSEMBLY

Mark	Quantity	Part Number	Description
1	1	101000	Main Frame
2	1	105090	Conveyor Belt - Laced
3	5	105006	Skirt Board Rubber Set
4	2	101075	Skirt Board Rubber Retainer Strip
4	2	101110	Skirt Board Rubber Retainer Strip
4	2	101115	Skirt Board Rubber Retainer Strip
4	2	101065	Skirt Board Rubber Retainer Strip
4	2	101085	Skirt Board Rubber Retainer Strip
5	57		3/8" x 1-1/2" Hex Head Bolt
6	57		3/8" Nylock Nut
7	57		3/8" Flat Washer
8	2	103030	Guide Roller Pins
9	2		3/8" x 1-1/2" Hex Head Bolt
10	2		3/8" Nylock Nut
11	4	919390	Guide Roller
			Optional Belt Service Parts
	1	919270	Lace Kit
	1	919295	Punch
	1	919290	Wrench
	1	919285	24" Template

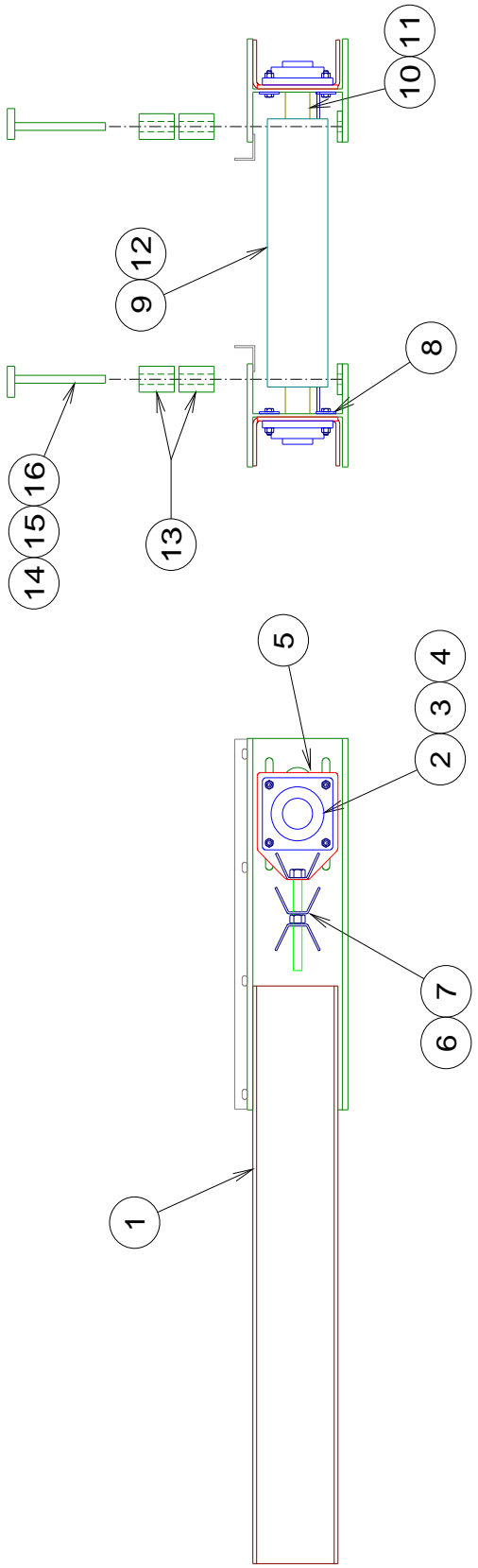

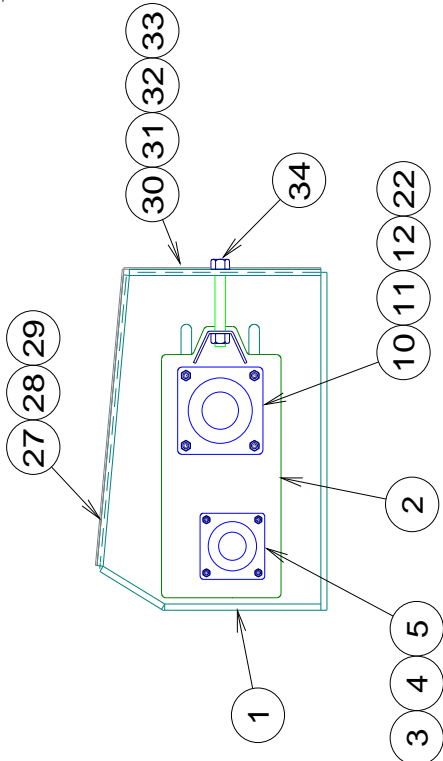
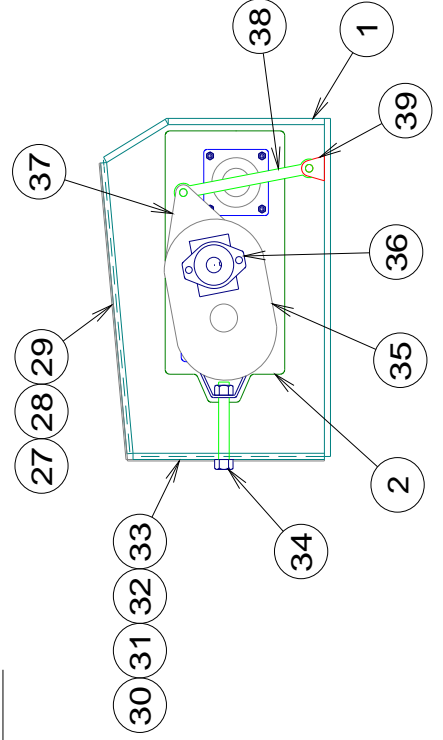
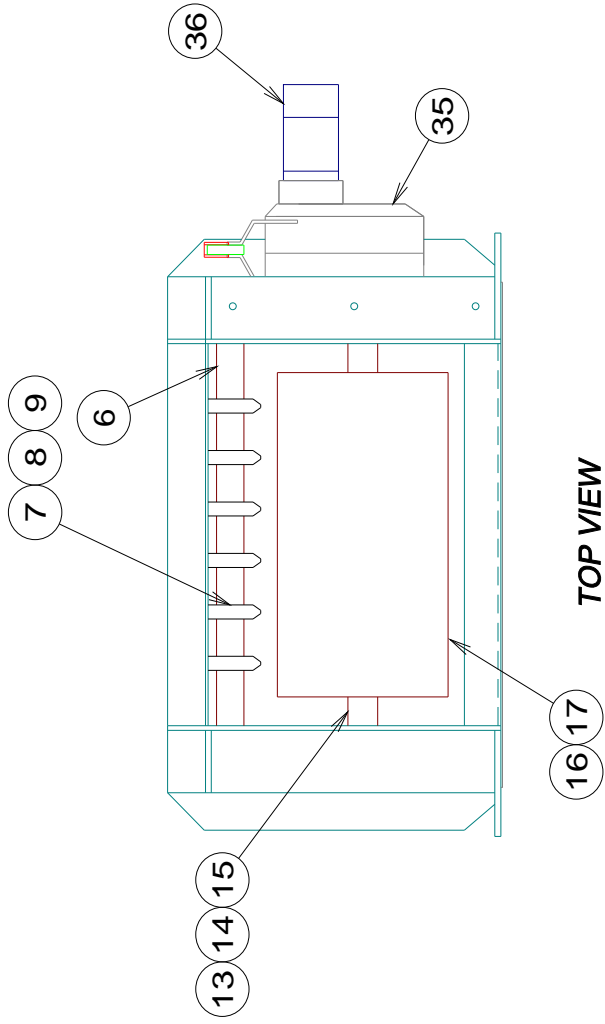

POWER UNIT ASSEMBLY

Mark	Quantity	Part Number	Description
1	1	102000	Power Unit
2	2	102100	Drive Pulley Adjustment Plate
3	2	919045	4 Bolt - 2-1/4" Flange Bearing
4	8		9/16" x 1-3/4" Hex Head Bolt
5	8		9/16" Nylock Nut
6	1	921403	Snubber Shaft
7	12		2-1/4" x 12 Ga. Machined Bushing
8	6	919380	Marco Rubber Donut
9	12		2-1/4" External Snap Ring
10	2	919040	4 Bolt - 2-7/16" Flange Bearing
11	8		5/8" x 2-3/4" Hex Head Bolt
12	8		5/8" Nylock Nut
13	1	921406	Drive Pulley Shaft
14	2	922150	5/8" Key
15	1	922140	1/2" Key
16	2	919180	Taper Lock Bushing with Screws
17	1	105007	Drive Pulley with Lagging
22	4	103060	Bearing Bolt Retainer Plate
27	1	100030	Top Cover Plate
28	6		1/2" x 1-1/2" Hex Head Bolt
29	6		1/2" Nylock Nut
30	1	100100	Rear Screen Guard
31	4		3/8" x 1-1/2" Hex Head Bolt
32	4		3/8" Nut
33	4		3/8" Flat Washer
34	2	102110	Slide Plate Adjuster Bolt
35	1	919010	Speed Reducer
36	1	918700	Hydraulic Motor
37	2		Upper Torque Arm Bracket
38	1	100040	Torque Arm
39	1		Lower Torque Arm Bracket

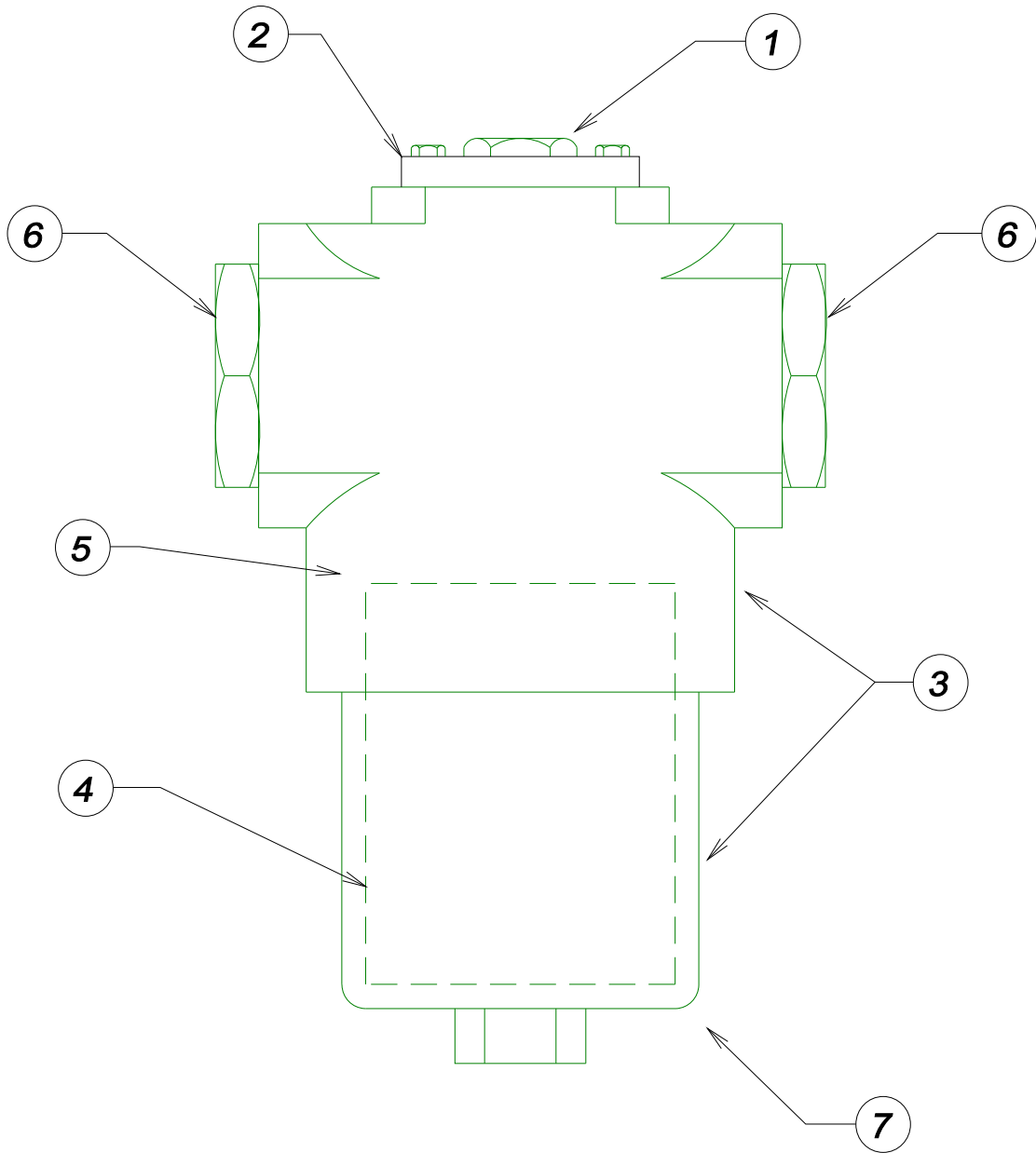

HIGH PRESSURE FILTER

918600

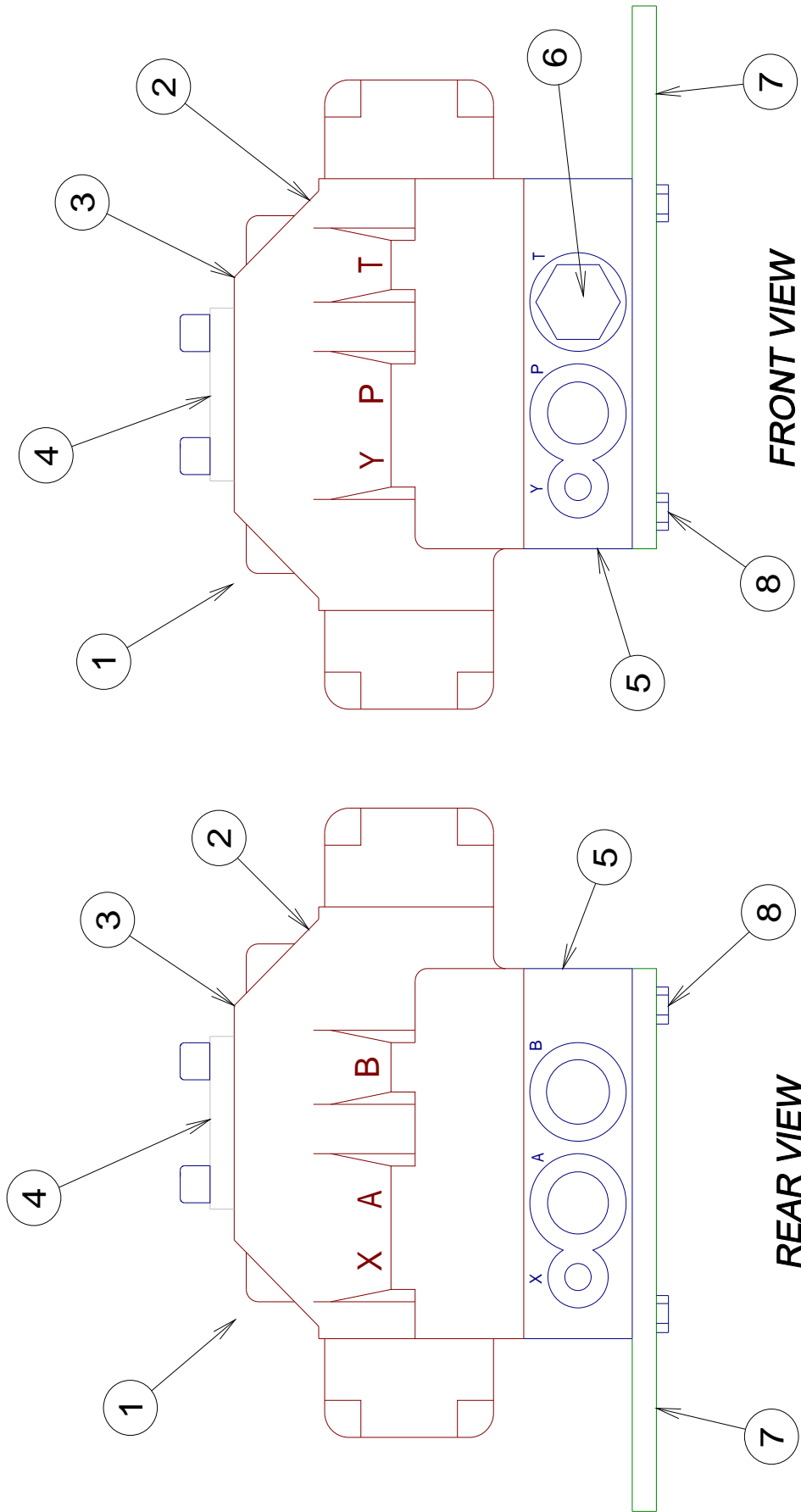

REXROTH HYDRAULIC SELECTOR VALVE 3490

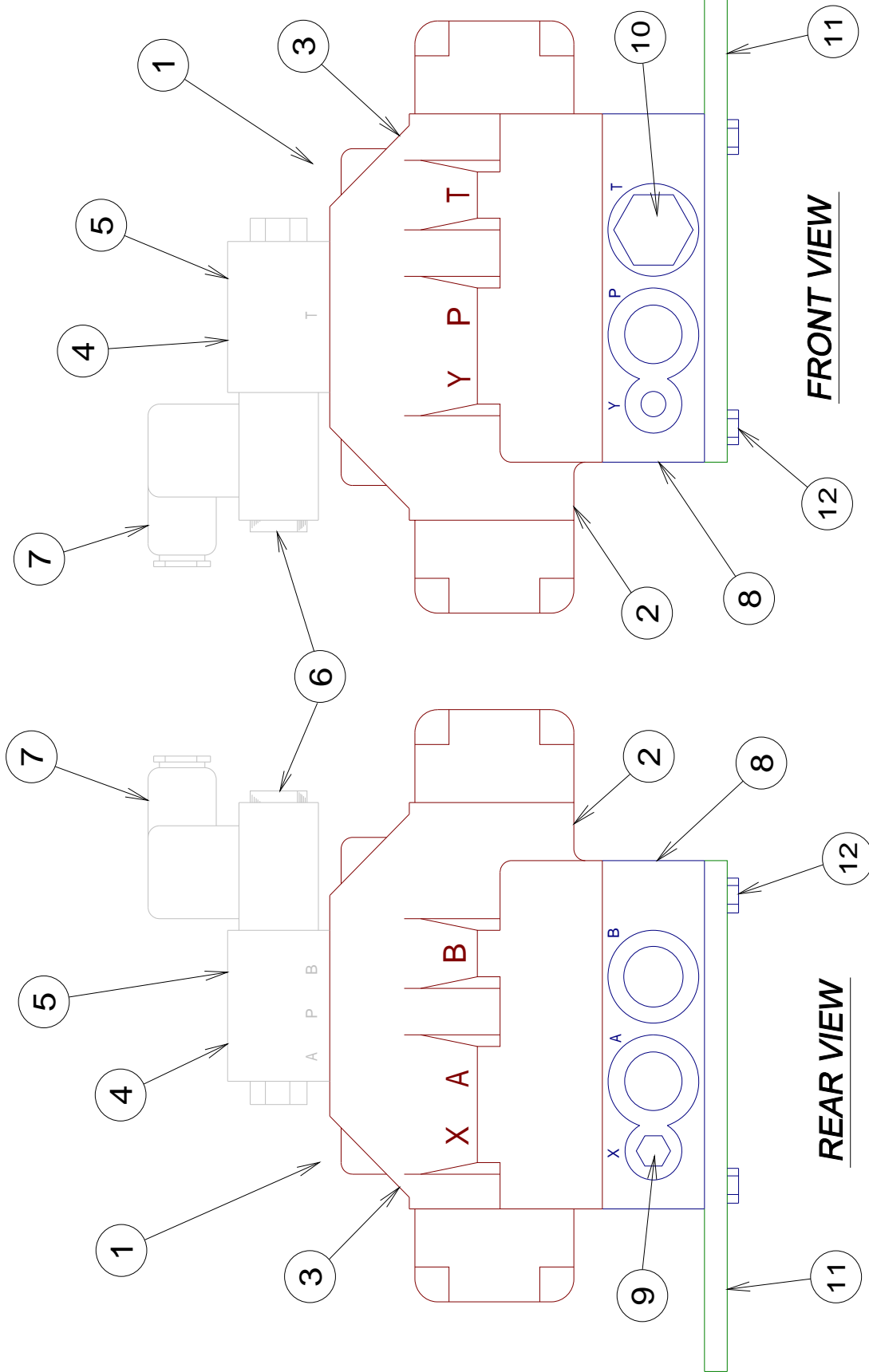

REXROTH ELECTRIC SELECTOR VALVE 3491

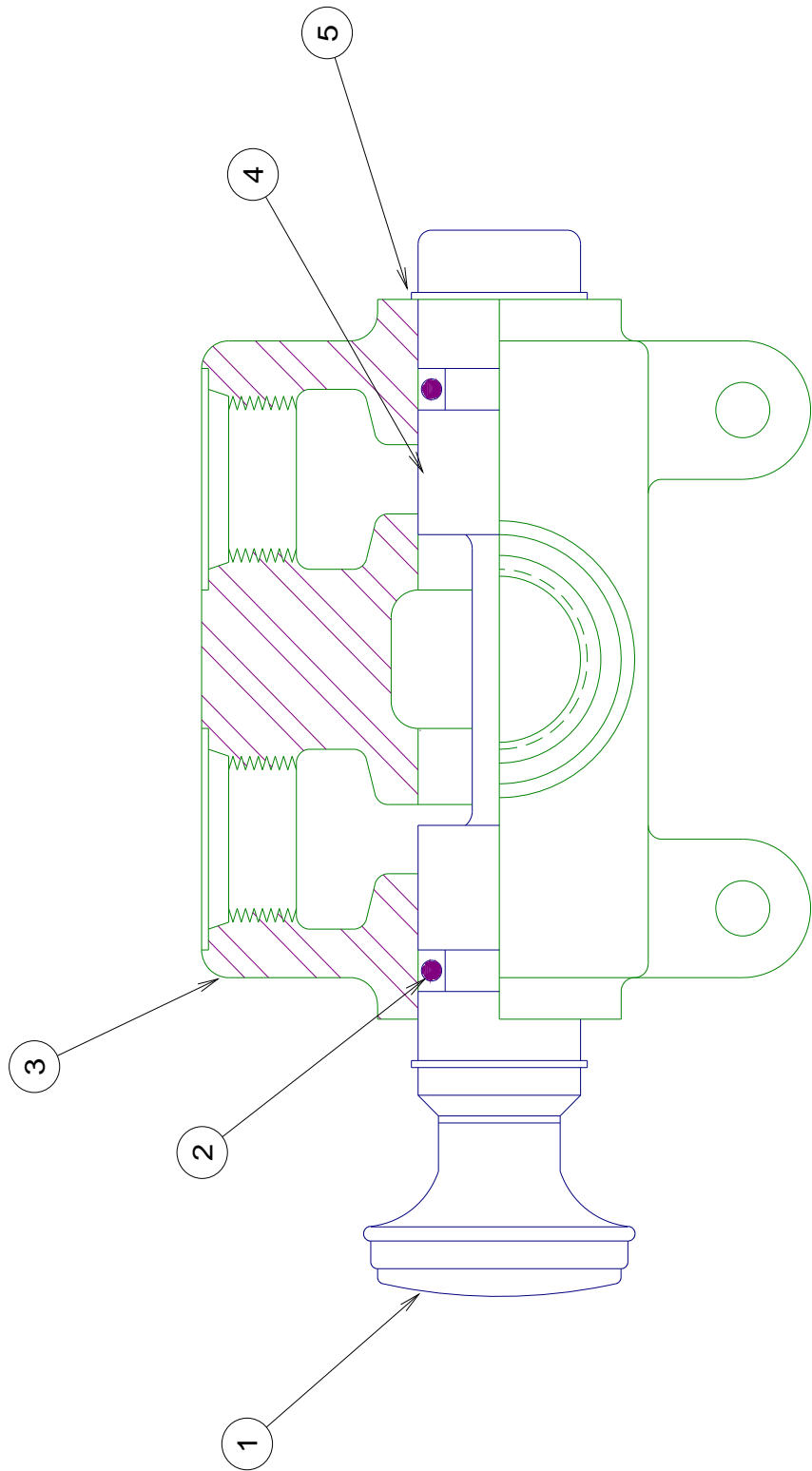

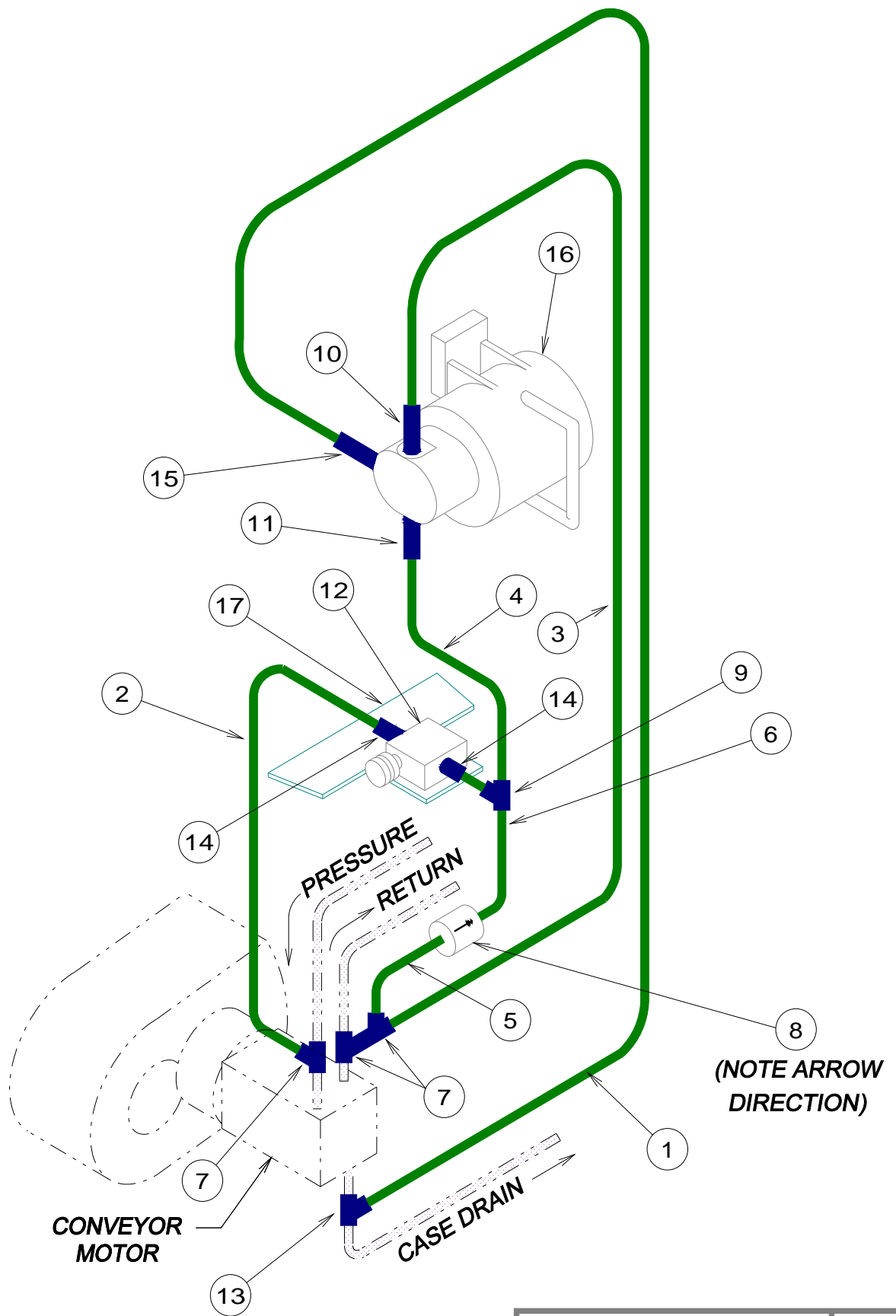

HYDRAULIC PLUMBING
 HOPPER VIBRATOR

3650

VIBRATOR HYDRAULIC PLUMBING

Mark	Quantity	Part Number	Description
1	1	918455 918060 918300	Hose Assembly - 48"
2	1	918455 918075 918300	Hose Assembly - 38"
3	1	918455 918075	Hose Assembly - 40"
4	1	918455 918075 918300	Hose Assembly - 20"
5	1	918455 918060	Hose Assembly - 10"
6	1	918455 918060	Hose Assembly - 18"
7	3	916880	Run Tee Adapter
8	1	918521	Check Valve
9	1	916970	Branch Tee Adapter
10	1	916565	O-ring Adapter
11	1	917360	O-ring Adapter
12	1	918690	Flow Control Valve
13	1	916870	Run Tee Adapter
14	2	917310	O-ring Adapter
15	1	917310	O-ring Adapter
16	1	918740	Vibrator Unit
17	1	105066	Mounting Plate
18	2		3/4" x 2-1/2" Bolt with 3/4" Lock Washer

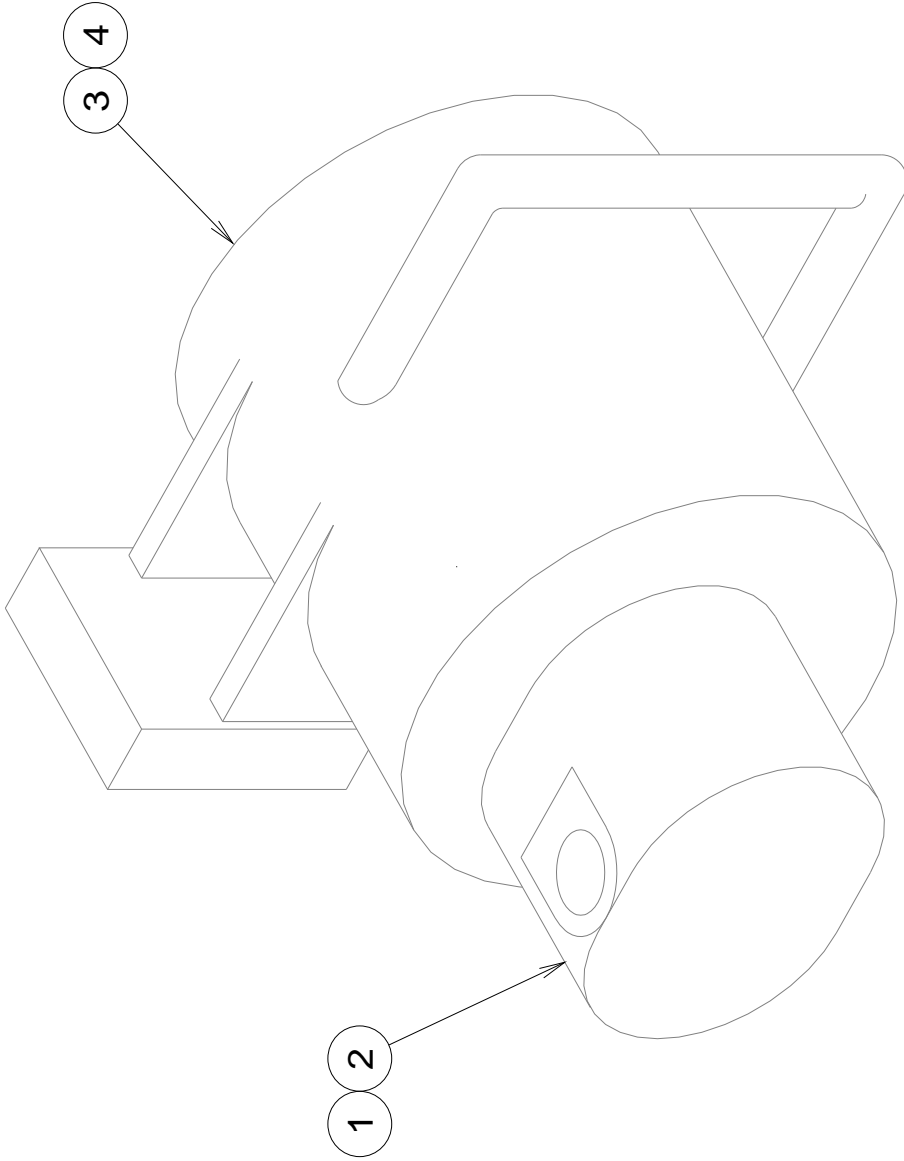

5 VIBRATOR UNIT - COMPLETE

VIBRATOR UNIT 3662

8 COMPLETE CONTACT RAIL ASSEMBLY

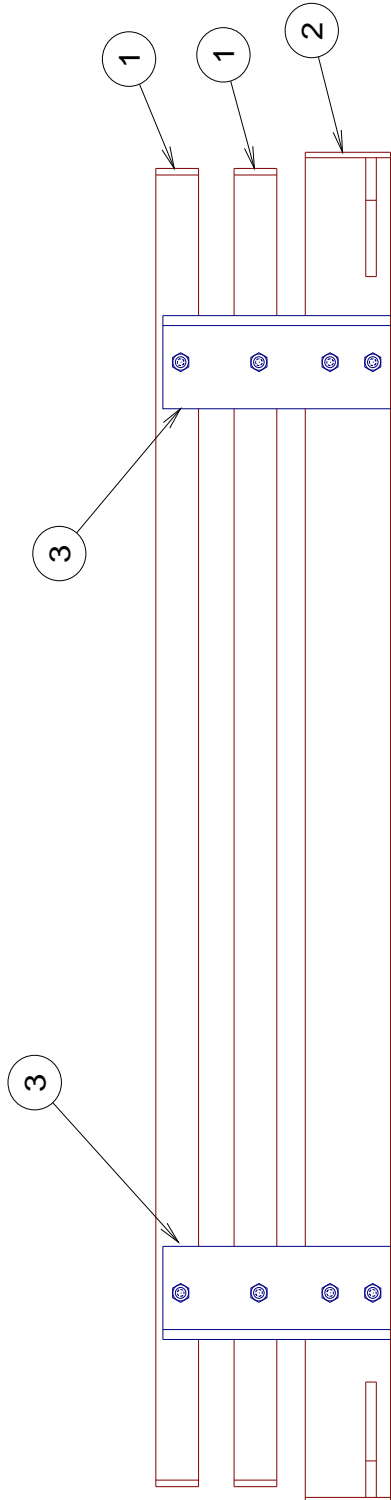
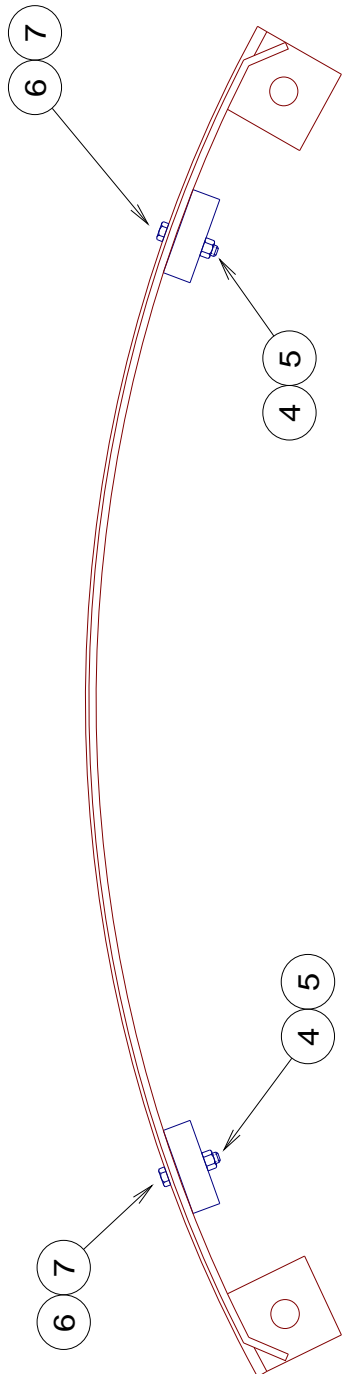

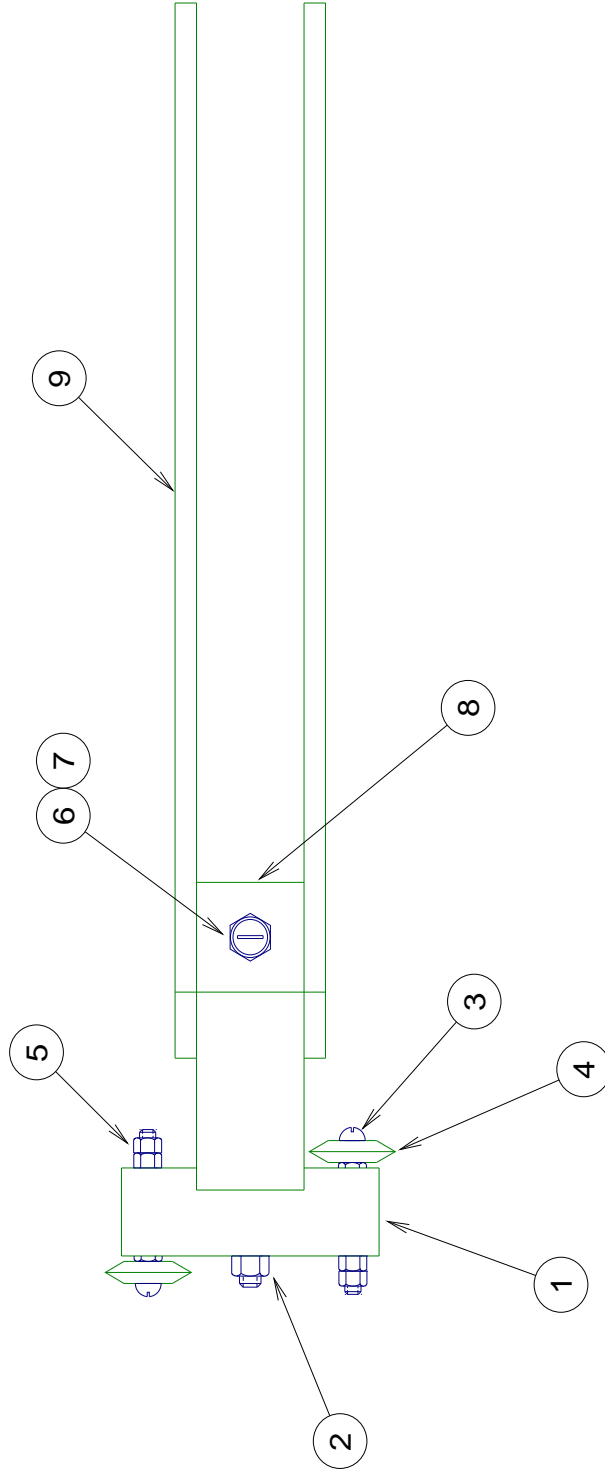

⑩ COMPLETE ROLLER CONTACT ASSEMBLY

Section 9

Hydraulic Schematics

The schematics shown are for all types of excavators. Contact Felco's Technical Service Department to determine which schematic is correct for your machine

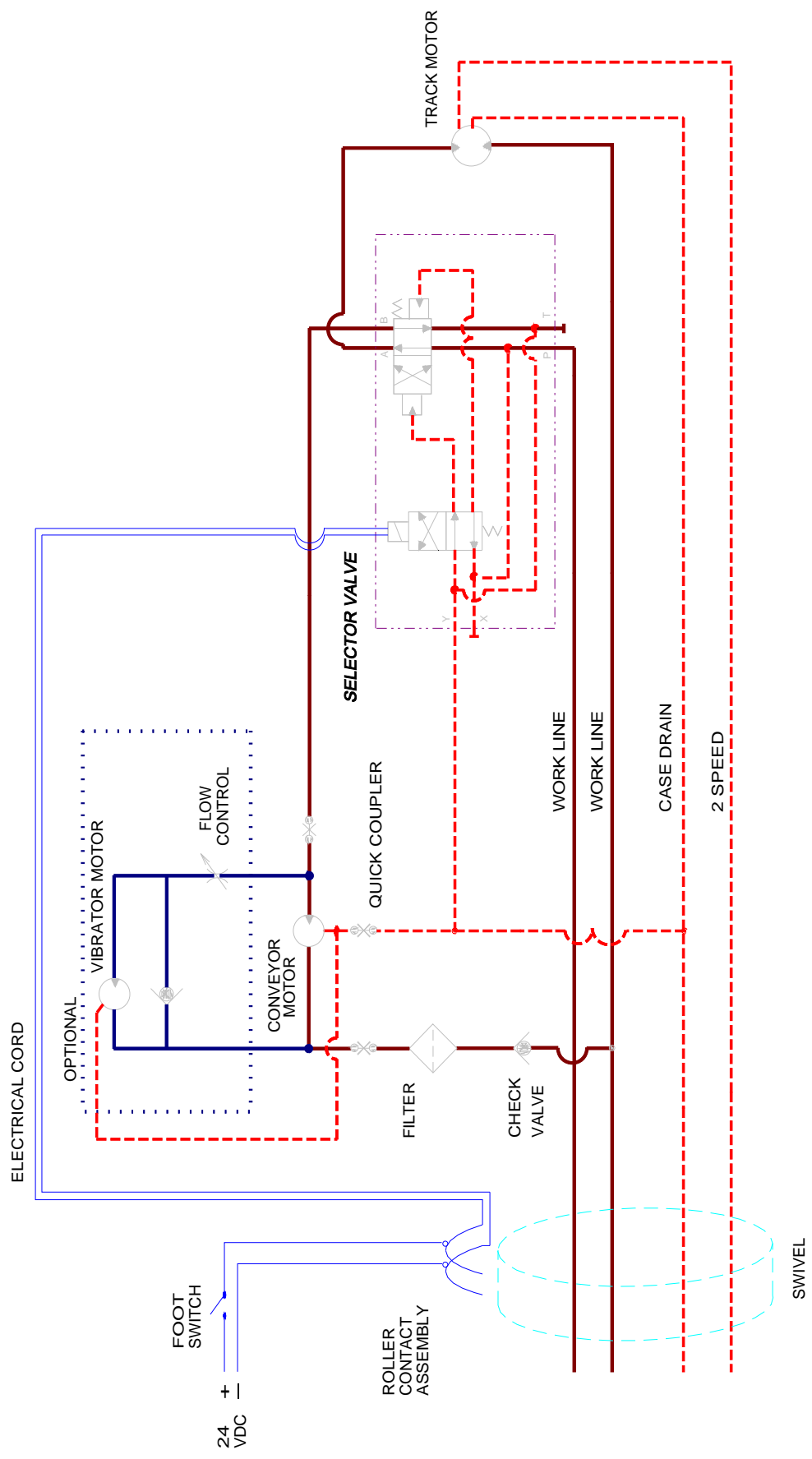

HYDRAULIC SCHEMATIC
 FULL FLOW DIVERTER
 (ELECTRIC CONTROL)
 DRAWING # 2011

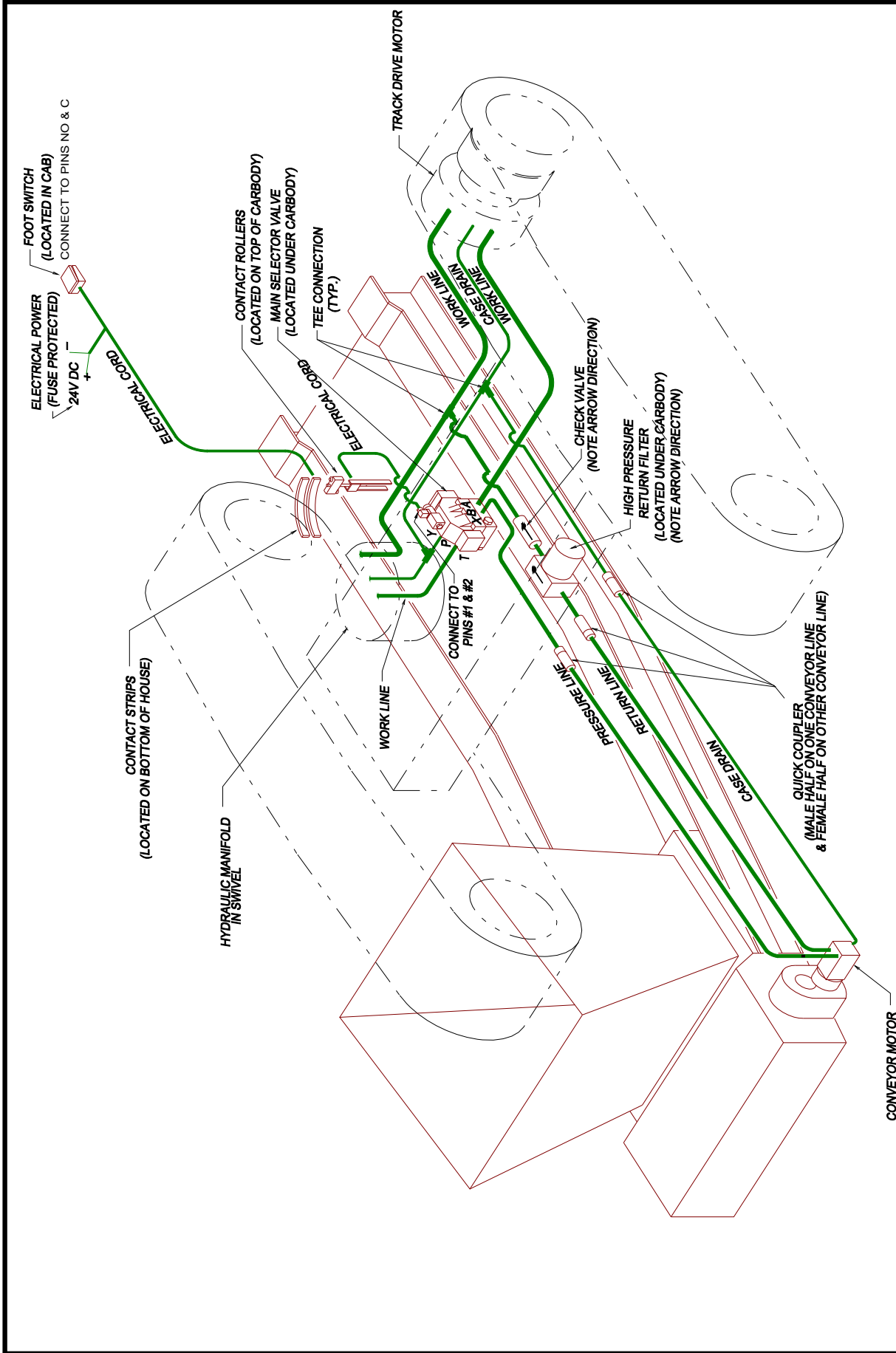

HYDRAULIC PLUMBING
 FULL FLOW DIVERTER
 ELECTRIC CONTROL

3121

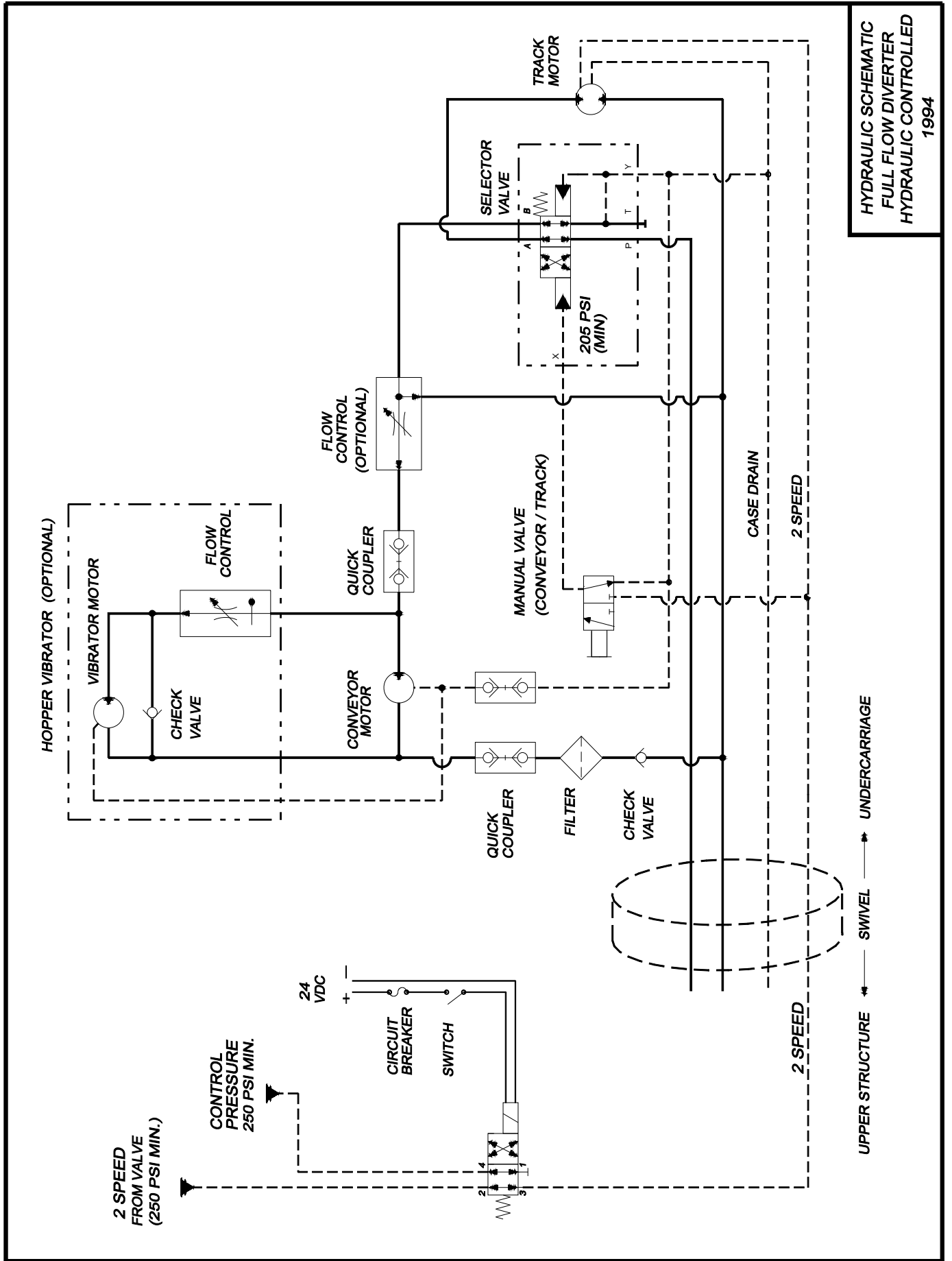

HYDRAULIC SCHEMATIC
 FULL FLOW DIVERTER
 HYDRAULIC CONTROLLED
 1994

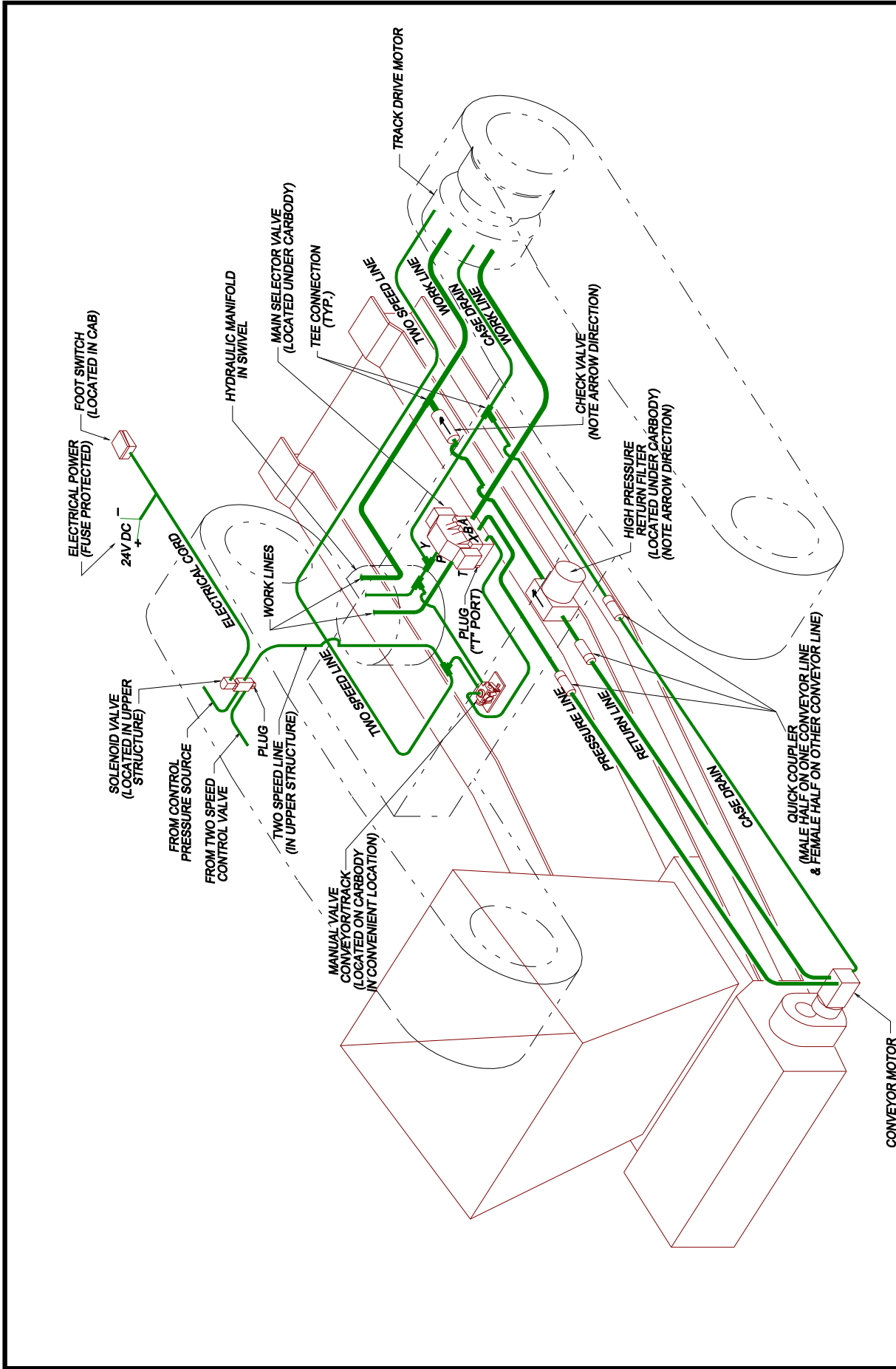

HYDRAULIC PLUMBING
 FULL FLOW DIVERTER
 HYDRAULIC CONTROL

3131

